

ACC-COM-LAN

Communications Module (for Ethernet connections)

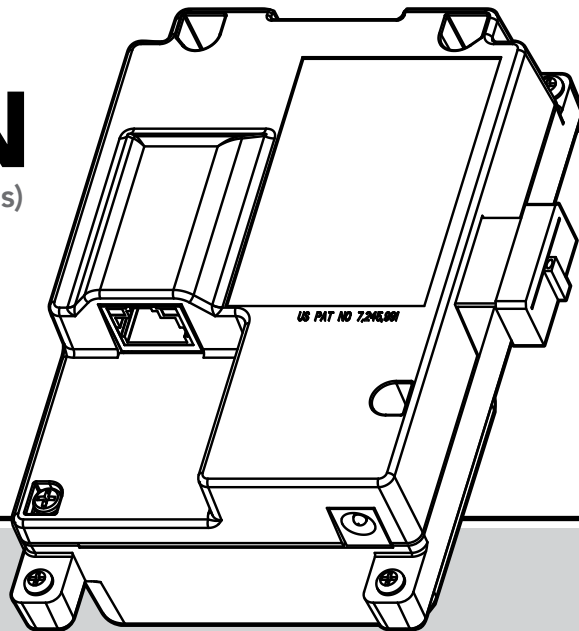

NEW

ACC-COM-LAN Communications Module (for Ethernet connections)

Owner's Manual & Installation Instructions

Hunter[®]

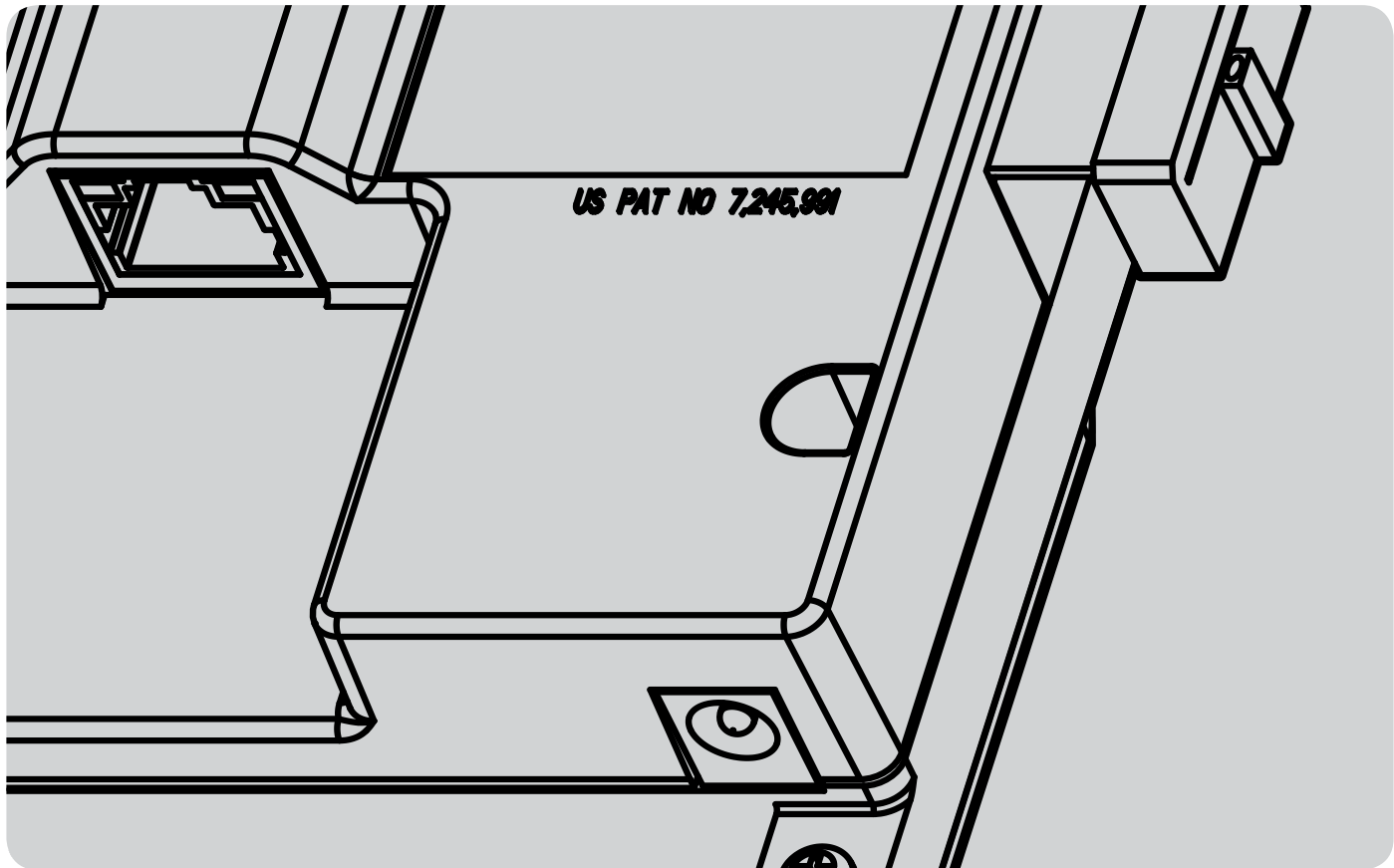

US PAT NO 7,245,991

TABLE OF CONTENTS

INTRODUCTION	2	Troubleshooting	16
This Package Includes	2	If the Wrong IP Address Is Sent to a Com Module by Mistake	17
Network Configuration Checklist	2	Other Com Setup Functions	17
Theory of Operation	3	Controller Address	17
Plan Ahead For Controller Mounting	3	Contrast	17
Wall Mount Installation	4	Radio Configure	17
Optional Radio Installation, Additional Steps	4	Radio	17
Radio Connections, Additional Steps	6	Last MR Cmd	18
Plastic Pedestal Installation	6	DTMF Wait	18
Radio Installation, Additional Steps	7	MR Default Run Time	18
SETUP AND ADDRESSING OF THE COM MODULE	8	HWIM	19
Com Module Controls	8	Enter Diagnostics	19
Set the Controller Address	8	Communications Status Display [MOD RAD HW]	19
LAN INFO (ETHERNET SETUP)	10	Radio Tone Test	20
Log the LAN IP and Controller Addresses	10	Ping Test	20
Assigning Permanent IP Address	10	Soft Reset	20
Crossover Cable	11	Total Reset	20
Network	11	Operating the Com Module	21
Submit	15	UHF Radio	21
Reboot	15	Hardwired Cable	21
Port Number	16	CONTROLLER SETUP TABLE	22
Other Settings	16		

INTRODUCTION

This Package Includes:

- (1) ACC-COM-LAN Communications Module
- (4) Mounting Screws
- (1) Instruction Sheet

Recommended Tools/supplies (not included):

- Small Phillips-head screwdriver with magnetic tip
- Small flat-bladed screwdriver
- UTP Category 5 or 6 cable with RJ-45 connector
- Optional network crossover cable for direct connection
- Additional tools and hardware as required for antenna mounting (radio only)
- Pedestal Mount requires APPBRKT (sold separately)

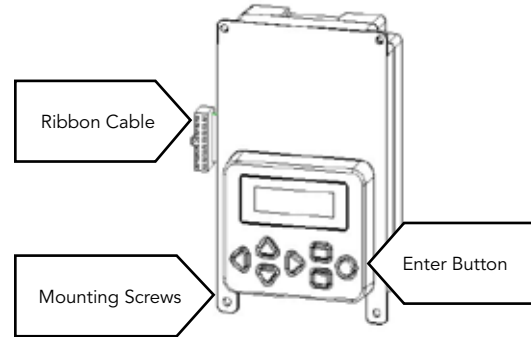

The ACC-COM-LAN provides Ethernet communications for ACC/AGC series controllers from a central computer.

This module may be installed in wall mounted or pedestal mounted controllers.

Network Configuration Checklist

Before installing this device, the Network Administrator for the Ethernet network will need to provide the following information.

INTRODUCTION

This is required in advance or the installation cannot be completed.

- Default Gateway: _____
- Subnet Mask (explicit or CIDR): _____
- DNS (Primary): _____
- DNS (Secondary, if applicable): _____
- IP Address (fixed IP required for each controller):

Theory of Operation

The ACC-COM-LAN Com module is an Ethernet modem and communications manager. It will contain the controller's unique identification (address), and enables communications into and out of the controller when combined with other devices.

ACC-COM-LAN contains an Ethernet modem, and requires a fixed (static) IP address in addition to the controller address. The fixed IP address must be accessible from the IMMS computer. Please contact your local network administrator for your specific network details.

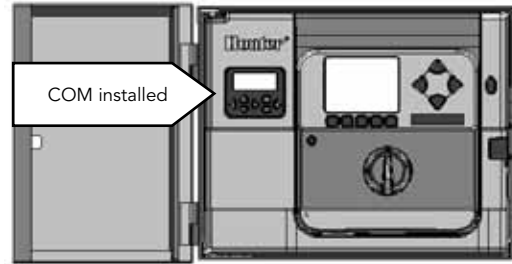

The ACC-COM-LAN may also communicate with other controllers, via optional UHF radio modules (sold separately) with an antenna for wireless communications, and/or an ACC-HWIM hardware interface module (sold separately) for hardwired communications over Hunter GCBL cable. The other controllers will not have an IP address, and will use the controller address only for hardwire and radio communications.

Plan Ahead For Controller Mounting

The ACC-COM-LAN depends on the local area network for communications. The controller must be mounted within 300 feet/100 m of an Ethernet jack.

INTRODUCTION

The ACC-COM-LAN is equipped with a standard RJ-45 style Ethernet connector, and is designed for use with unshielded twisted pair (UTP) Category 5, CAT5e, or CAT6 cable.

Wall Mount Installation

Turn controller AC power off.

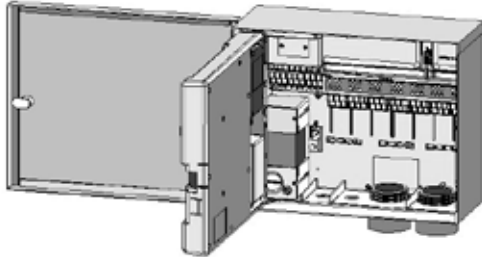

- Remove the facepack door frame: Disconnect facepack door frame ribbon cable, open and lift up the door frame to compress the top hinge, and tilt out of the lower hinge
- Locate the communications compartment cover on the back right side of the frame
- Remove the communications compartment cover (6 screws)

- Remove the ACC logo cover (2 screws)

Optional Radio Installation, Additional Steps:

If the Com module will be used with a RAD3 radio, the radio ribbon cable should be connected to the Com module now, before installing the ACC-COM-LAN into its compartment.

- The radio ribbon cable has a rectangular 14-pin connector on one end for the Com module, and a DB-15 pin connector on the other end for connection to the radio. The 14-pin connector only plugs one way, and is keyed to assist proper orientation. Align the connector and push into place on the top of the Com module.
- When the Com module is installed in the opening, make sure that the ribbon cable is visible on the back of the unit, for connection to the RAD3 radio module

INTRODUCTION



1. Route the network connector cable into the wiring compartment via the low voltage conduit openings. Connect to the jack on the back of the ACC-COM-LAN modem, and insert until it clicks positively into place.
2. Route the radio antenna cable (if applicable) through the recessed track next to the radio compartment, and then through the low voltage conduit openings in the cabinet, for connection to external antenna.
3. Leave sufficient slack in the cables to allow the door to open and close without crimping.

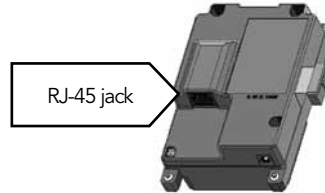

4. Insert the ACC-COM module into the opening where the logo cover was, with the display and buttons protruding through the opening. Secure with 4 screws (supplied) on each corner. The screws are recessed and a small magnetic tip screwdriver is very helpful for this task.
5. Carefully insert the modular ribbon connector plug from the Com module into the mating receptacle in the door frame. This connector is keyed and has slots which must be aligned correctly, so that the connector can only fit one way. The ribbon cable can be extended or shortened slightly by pushing it back into the com module slot. Press firmly to make sure that the connector is fully seated.

INTRODUCTION

Radio Connections, Additional Steps:

- Before installing the RAD3 radio module, connect the DB-15 connector from the ribbon cable to the top of the RAD3 radio and secure with the connector screws (do not overtighten)
- Connect the male BNC radio antenna connector to the AIM-BNC antenna isolator, before installing the radio into the radio compartment
- Connect the AIM-BNC to the radio antenna
- Install the radio into the radio compartment (see RAD3 installation instructions for additional information)

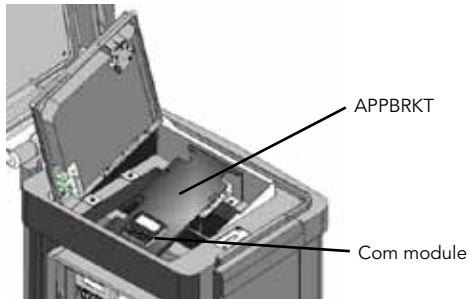

Reapply controller power and verify that the Com module display lights up and displays characters.

If there is no display:

Double check ribbon cable connection from Com module to facepack door frame receptacle.

Double check ribbon cable from facepack door frame to controller cabinet.

Plastic Pedestal Installation

Requires APPBRKT communications bracket, sold separately

Turn controller AC power off with the AC power switch in the pedestal.

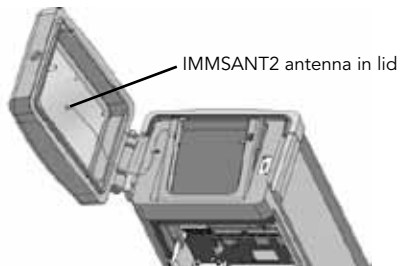

INTRODUCTION

Open the facepack frame in the top of the pedestal, to expose the communications module mounting area.

Install the ACC-COM-LAN into the APPBRKT mounting bracket. Secure the Com module with screws on each of the 4 corners.

Note: Use the screws supplied with the APPBRKT to mount the com module.

Install the APPBRKT communications bracket beneath the facepack. This bracket is designed to hold the Com module and a radio module (if radio is required). If the controller is already permanently installed, it is not necessary to screw down the APPBRKT. Screws are supplied only to secure the bracket if additional shipping or movement of the controller is necessary.

Radio Installation, Additional Steps:

If radio communications will be used, connect the radio module cables to the Com module with its ribbon cable and power connector first.

Install the Com module into the bracket, and then install the radio on the APPBRKT with supplied hardware.

Install IMMS-ANT-2 in pedestal lid.

Route antenna cable from the IMMS-ANT-2 through the slot in the metal frame for the facepack, down into the controller to the radio location.

Connect the cable connector to the radio module (be sure to turn the BNC connector until it locks into place).

Install the plastic cable guide (P-) with self tapping screw as shown. Adjust cable before tightening to insure that there is only enough slack to allow the lid to open and close, without causing the cable to be pinched.

Connect the ACC-COM-LAN ribbon cable extension to the controller facepack connection on the underside of the facepack frame. This is the keyed 14-pin connector, top left, above the main facepack ribbon connection.

Reapply controller power and verify that all devices power up and have displays. Proceed to Setup and Addressing of the Com module, in the next section.

SETUP AND ADDRESSING OF THE COM MODULE



When powered up, the Com module display will show the version number, and will automatically check to see what other communications devices are installed.

Note the version number and include it whenever seeking technical assistance from Hunter Industries via phone or email.

If the Ethernet cable is connected to the Com module, and to an active Ethernet connection, the display will show a letter "L" in the upper right corner of the display. The device is ready for central communications when the "L" block appears). If the "L" does not appear, troubleshoot the Ethernet jack and the Ethernet cable.

Com Module Controls

The Com module controls use the up and down arrow buttons to make selections, a + and – button to change individual settings, and an Enter key (far right) to save settings.

Set the Controller Address

The controller ID, or address, is required before any communications can take place. This address is required for central control, and is different than the IP address used by the Ethernet system. An address may be any number between 1 and 999. Each controller must have a unique address, different from all other controllers on the site.

Press the Up arrow once. The display will show controller Address. The Address will be 000 if the module is new.

Press Enter to enter the Address edit mode. The address number will blink. You can use the left and right arrow buttons to move through each of the three number fields.

Use the + or – buttons to change the Address to the desired setting. If you hold the + or – button for more than a second, the numbers will change faster. You can go forward or backward with the + and – buttons to set the exact number.

SETUP AND ADDRESSING OF THE COM MODULE

Press the Enter button to enter the Address when all 3 digits are correct. The controller will now be addressed.

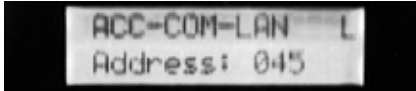

The controller Address is assigned to a Com module, not to the ACC facepack. The controller Address can be reprogrammed at any time with the buttons. The controller Address is different than the IP Address, and both must be configured correctly for proper operation.

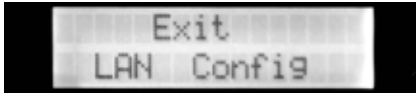

The controller Address can only be set and changed at the Com module itself.

LAN INFO (ETHERNET SETUP)

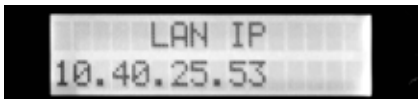

- When the L appears a few seconds after start up, verify first that the controller address is set
- Press the up arrow to access the “LAN Info” menu, and press the enter key
- The LAN IP screen will appear
- The Com module will be assigned a temporary LAN IP (Internet Protocol) address automatically by the network

Log the LAN IP and Controller Addresses

When installing a new LAN system, write down the initial LAN IP address numbers, along with the 3-digit controller addresses, for each controller in the system.

SAMPLE CONTROLLER SETUP TABLE		
Controller Name	Address	IP Address Temp/Fixed
Main Pumphouse	001	10.10.100
		10.40.5.126
Athletic Field	002	10.10.101
		10.40.31.219

The fixed IP numbers assigned by the network administrator will need to be entered into the Com modules after initial installation. These are assigned by addressing the Com module via the initial IP number, to re-configure the permanent IP.

A blank controller setup table is on the last page of this manual.

Assigning Permanent IP Address

The settings described in this section are best made with the help of a network systems administrator from the facility. At a minimum, the correct IP Address, Gateway, Subnet Mask, and DNS must be made for the system to function.

LAN INFO (ETHERNET SETUP)

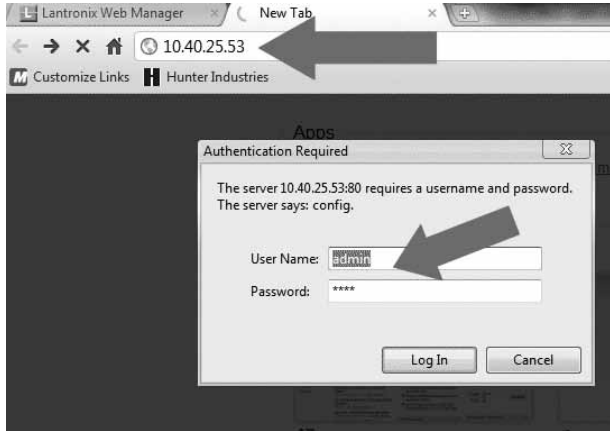

Use a computer on the network (usually the central control computer) and enter the initial IP number of the Com module in the address line of any internet browser.

A web page will open for the Com module that allows settings of the network modem. This page will require a User ID and a password. The initial default settings are:

User ID: admin (case sensitive)

Password: PASS (case sensitive)

These may be changed after the initial log on.

Crossover Cable

It may also be possible to access the module directly from a network-capable computer with an Ethernet crossover patch cable. This depends partly on the individual computer, as some computers have settings in the BIOS that may prevent this operation.

The Com module requires external power and should be installed in an ACC controller first. Connect the crossover cable to the Com module, and the other end to the computer. Once a temporary IP is assigned to the Com module, open a browser on the computer and enter the IP address as described in the Network section.

Hunter cannot provide support for individual computer settings, and the Network procedure outlined below is the recommended method of access for setup.

Network

Once you are logged into the web page for the module, click the Network menu item on the left side of the browser page.

LAN INFO (ETHERNET SETUP)

Status 

CLI

CPM

Diagnostics

DNS

Email

Filesystem

FTP

Host

HTTP

IP Address Filter

Line

LPD

Modbus

Network

PPP

Protocol Stack

Query Port

RSS

SNMP

Network 1

Interface Link

Status Configuration 

Network 1 (eth0) Interface Status

	Current	After Reboot
BOOTP Client:	Off	Off
DHCP Client:	Off	Off
IP Address:	10.40.25.53	10.40.25.53
Network Mask:	255.255.0.0	255.255.0.0
Default Gateway:	10.40.0.1	10.40.0.1
Hostname:	ACC-COM-LAN53	ACC-COM-LAN53
Domain:	hunter	hunter
DNS Suffix Search List:	hunter	<None>
DHCP Client ID:	<None>	<None>
MTU:	1500	1500

Status 

Device Status

CLI

CPM

Diagnostics

DNS

Email

Filesystem

FTP

Host

HTTP

IP Address Filter

Line

LPD

Modbus

Network 

PPP

Protocol Stack

Query Port

RSS

SNMP

SSH

SSL

Syslog

System

Product Information

Product Type:	Lantronix XPort Pro
Firmware Version:	5.2.0.0R20
Build Date:	Dec 1 2010 (10:04:58)
Serial Number:	07093207T7FPAQ
Uptime:	4 days 23:56:57
Permanent Config:	Saved

Network Settings

Interface:	eth0
Link:	Auto 10/100 Mbps Auto I
MAC Address:	00:20:4a:be:94:d2
Hostname:	
IP Address:	
Default Gateway:	
Domain:	
Primary DNS:	
Secondary DNS:	
MTU:	1500
VIP Conduit:	Disabled

Line Settings

Line 1:	RS232, 9600, None, 8, 1
---------	-------------------------

Tunneling

Connect	
---------	--

LAN INFO (ETHERNET SETUP)

At the top of the Network page, choose **Configuration**.

Make the following settings:

BOOTP Client: Leave Off.

DHCP Client: Set to Off. This will be On when you enter the screen.

The screenshot displays the 'Network 1 (eth0) Interface Configuration' page. On the left is a vertical navigation menu with 'Network' highlighted. The main content area shows a header for 'Network 1' with 'Interface' and 'Link' buttons. Below that is a 'Status Configuration' section. The configuration table includes the following fields:

BOOTP Client:	<input type="radio"/> On <input checked="" type="radio"/> Off
DHCP Client:	<input type="radio"/> On <input checked="" type="radio"/> Off
IP Address:	XX.XX.XX.XX
Default Gateway:	XX.XX.X.X
Hostname:	ACC-COM-LAN
Domain:	
DHCP Client ID:	<input type="text"/>
	<input checked="" type="radio"/> Text <input type="radio"/> Binary
Primary DNS:	XX.XX.X.XX
Secondary DNS:	XX.XX.X.XX
MTU:	1500

A 'Submit' button is located at the bottom right of the configuration table.

DHCP allows the device to receive a temporary IP automatically when first connected, but will cause problems if left On after a Reboot. It will prevent the fixed IP from being used, and may cause a new IP to be assigned. It must now be set to Off.

LAN INFO (ETHERNET SETUP)

IP Address & Subnet Mask: Enter the fixed IP address followed by a space, and then the Subnet Mask.

Note this may change after saving to a “CIDR” format, where the full mask is replaced by a shortened version (/16, etc). This is OK.

Default Gateway: Enter the Default Gateway provided by the network administrator.

Hostname: Leave blank.

Domain: Leave blank.

DHCP Client ID: Leave blank.

Primary DNS: Enter the DNS information provided by the network administrator. The primary DNS is required.

Secondary DNS: Enter a secondary DNS if applicable. Not all systems will provide a secondary DNS. This is OK.

MTU: Leave at the default setting of 1500.

LAN INFO (ETHERNET SETUP)

Submit

☑ Text ☐ Binary

Primary DNS:	<input type="text" value="xx.xx.x.xx"/>
Secondary DNS:	<input type="text" value="xx.xx.x.xx"/>
MTU:	<input type="text" value="1500"/>

As soon as you change the IP Address, or any other field on the screen, a Submit button will appear at the bottom of the page to send the information to the Ethernet modem.

When you are sure the IP Address, Subnet Mask, Gateway, and DNS information are correct, and DHCP Client is set to Off, click the Submit button.

Reboot

Status

- CLI
- CPM
- Diagnostics
- DNS
- Email
- Filesystem
- FTP
- Host
- HTTP
- IP Address Filter
- Line
- LPD
- Network
- PPP
- Protocol Stack
- Query Port
- RSS
- SNMP
- SSH
- SSL
- Syslog
- System
- Terminal

System

Reboot Device

Restore Factory Defaults

Upload New Firmware

Name

Short Name:

Long Name:

Current Configuration

Firmware Version:	5.0.0.0R14
System Name:	xport_pro
System Model:	Lantronix XPort Pro

LAN INFO (ETHERNET SETUP)

After changing these settings and submitting them to the Ethernet modem, you must reboot the Com module to put them into effect.

Click the System menu item on the left. Under Reboot Device, click the Reboot button.

To see the device in the browser window after a reboot, enter the new IP in the address line. Log on again using the admin ID and password. The modem is now ready for normal central control operations.

Exit: Exits the LAN Info sub menu.

Port Number

The default port number for each ACC-COM-LAN is 10001.

Hunter does not recommend changing the port number.

Other Settings

Many other settings are available through the setup page. These are not required for basic irrigation control operations, and should only be adjusted by the network administrators.

Do not change any setting without a complete understanding of its effects on performance.

Troubleshooting

If the "L" does not appear in the Com module display, first verify that green and amber lights are present at the connector on the back of the Com module, where the Ethernet jack is inserted.

If no lights are present, troubleshoot Ethernet cable and verify that the Ethernet connection is active.

If the lights are present but no L appears, use the Diagnostics functions to perform a Total Reset of the Com module.



Network Lights (back of Com module)

LAN INFO (ETHERNET SETUP)

If the Wrong IP Address Is Sent to a Com Module by Mistake:

Go to the controller location and perform a Total Reset on the Com module (Diagnostics menu).

Wait for the Com module to show an L in the display again.

Enter the controller address again.

Use the LAN Info menu to view the new temporary IP Address.

Write the new IP address down, and repeat the steps for Assigning Permanent IP Address.

Whenever the Com module is actively communicating with the control system via the network, the display will show "Connected".

Other Com Setup Functions

ACC-COM-LAN detects other communications connections and displays information about them. It also allows operator control of some settings and functions.

Use the Up or Down arrow to navigate through main topics.

Controller Address:

Shows current address setting. Press Enter to change, + or – to change. The address can be any number from 1 to 999. If the + or – buttons are held down, the number will begin to change in increments of 10 to speed up the setting process. If setting a very high number, use this feature to get close to the number, release, and use = or – to get the exact address (you can also use the "-" button to go backwards from 1). Press Enter when the correct number is shown.

Contrast:

Default = 50. Adjusts display visibility for varying conditions. Press Enter to adjust, + or – to change, and press Enter when done.

The display contrast may be adjusted for daylight conditions where reflection makes the display difficult to read.

Radio Configure:

Press Enter to view the radio setup menu.

Radio:

Shows a type of radio module, if one is found by the Com module. Shows N/A if no radio is detected.

LAN INFO (ETHERNET SETUP)

Radio communications can be used in 2 different ways:

- To connect a controller to additional controllers within the same Site.
- To use a UHF Maintenance Radio (Hunter Model TRNR) as a remote control for the controller.

Last MR Cmd

(Radio Only): Displays the characters in the last-received UHF Maintenance Radio command, for diagnostic purposes. This setting is not shown if there is no radio. This setting only applies to UHF Maintenance Radio and will not show ICR remote commands.

DTMF Wait

(Radio Only): Sets amount of time allowed between characters in a Maintenance Radio command, 1 – 5 seconds. The purpose of this setting (default = 2 seconds) is to tell the Com module how long to wait after hearing DTMF Maintenance Radio commands, before assuming the command is complete.

Maintenance Radio commands are sent from a UHF portable radio by pressing buttons which send DTMF (Dual Tone Multi-Frequency, also known as Touch-Tones) tones to the Com module. When a command has been started, the Com module assumes it

is finished when the DTMF Wait period has elapsed or the radio carrier signal stops, with no more tones.

A longer DTMF wait allows slower typing speeds of the command on the radio. The trade-off is that the longer wait means that it will take longer for the action to be carried out (in other words, if the Wait is 5 seconds, it will be 5 full seconds after the command has been sent before the sprinkler turns on).

This setting is not shown if there is no radio. This setting does not affect ICR remote commands.

MR Default Run Time

(Radio Only): Default = 30 Minutes. This sets the automatic run time for any station or SSG that is started by a Maintenance Radio command, if no run time has been specified in the On command. It is possible to turn a station or SSG on without specifying a run time, and this setting will automatically turn them off after the specified time if they are not turned off by an Off command. The Default Run Time can be changed in 1 minute increments up to a maximum of 60 minutes. This setting is not shown if there is no radio and does not affect ICR remote commands.

LAN INFO (ETHERNET SETUP)

HWIM:

Indicates presence of a Hardwire Interface Module (ACC-HWIM) installed in the controller. "None" indicates no HWIM has been found, "Installed" indicates that the HWIM is installed and has been detected. This display is informational and cannot be changed from the Com module.

Enter Diagnostics:

To use the built-in communications diagnostics, press the Enter button at this display.

This will allow you to select from the following diagnostic functions (use the up or down arrow buttons to move through the choices).

When the Com module is communicating with the irrigation control system via the network, the display will show "Connected".

Communications Status Display [MOD RAD HW]

Pressing the left arrow button at any time will show a status display for communications, showing transmit and receive activity for each communications type. The display shows: "MOD RAD

HW #", indicating Modem, Radio, Hardwire, and number of data packets sent.

Under each item MOD, RAD, and HW, the letter T shows transmit activity and R shows receiving data for that communications component. The symbol * shows other radio traffic ("carrier detect"). This is a useful diagnostic tool.

MOD: Shows Ethernet modem activity. The T and R symbols here are equivalent to "Connected" in the main display, and indicate that the module is communicating with the control system.

RAD: Shows T when the controller radio is transmitting, and R when it is receiving data from another radio.

HW: Shows T when the controller is transmitting over GCBL cable, and R when receiving data via GCBL.

#: Shows the count of individual packets of data as they are exchanged. This number continues to increase as events are counted until it reaches 255, then begins again at 1.

Digital communications are divided into packets of data, and sent in pieces called "packets". After each packet is sent, a confirming response is expected. This counter tracks all communications in the module via radio, hardwire, and modem.

LAN INFO (ETHERNET SETUP)

The * may indicate other radio traffic (from other sources). Communications problems that cannot be explained by hardware issues are sometimes caused by interference from other sources. If * is frequently present when no ACC communications are taking place, it may indicate that the frequency is very busy.

Radio Tone Test

The radio test is only active when a RAD3 radio module is installed. Press the left arrow button twice to display the Radio Tone Test, and press Enter to start the test. The radio module will transmit a 5-second burst of data, to confirm whether the radio is working. The burst can be heard with another radio or scanner tuned to the same frequency.

For this test to be effective, you will need a two-way radio or scanner on the same frequency as the radio module.

- When the radio test is started, a burst of data indicates a working radio module in the controller.
- If nothing is heard, either the radio is inoperative or the wrong frequency has been selected for receiving.
- If a broken, rough-sounding, or very faint signal is heard, there may be a problem in the antenna, antenna cable, or connectors. This may also indicate a problem in the radio module, although antenna/cable/connectors are the more

likely cause. The easiest way to check this is to swap the radio module with a known good unit, connect to the same antenna and cable, and repeat the test... if the sound clears up, the problem was the module. If the sound is still poor, it is probably the antenna/cable/connector setup.

Ping Test

The ping test allows any controller to exchange communications with another controller for test purposes. To do this, select a Target controller from the Source controller. When the test is started, the Source controller will "ping" the Target controller repeatedly and show success or failure of the communications. Any other controllers which can hear the test will also show the results, while the test is taking place.

Soft Reset

This "reboots" the communications module if it is temporarily confused. If the display or controls appear to be locked up, soft reset will restart the module without erasing data.

Total Reset

This completely resets all data in the Com module. It will erase any settings including the address! If the com module is unresponsive and a soft reset does not solve the problem, Total

LAN INFO (ETHERNET SETUP)

reset allows you to start over with a clean installation. This is also useful when moving a Com module from one installation to another, or when you are uncertain what previous operators may have programmed into the module.

Operating the Com Module

With the Com module installed and operational (with L visible in the upper right of the display), verify that the controller address is correct.

The software documentation provides information on configuring Sites and the connections for each Site.

Once an ACC controller is connected via LAN, it can share the communications connection with other controllers via radio and hardwire.

The following considerations apply to these optional outbound connections.

UHF Radio

This module may also be used with a Hunter UHF radio, which must be ordered separately.

In steel enclosures, the antenna must be installed externally (signals will not communicate from inside a metal box).

- **Plan ahead for mounting an external antenna.** It will be necessary to route the antenna cable from the radio module inside the enclosure, to the antenna outside of the enclosure. A site survey with comparable radios is required before a final decision can be made about antenna types and placement.

In the plastic pedestal enclosure, the Hunter IMMS ANT 2 antenna is designed to be mounted in the pedestal lid and may be adequate for communications (to be determined in advance by site survey).

In North America and most other countries, **a license is required** before operating any UHF radio transmission equipment. Verify your local regulations and make sure that you have obtained the proper licensing before operating radio equipment.

Hardwired Cable:

This module does not contain a hardwire connection terminal.

Any controller needing hardwired communications must be equipped with an ACC-HWIM, in addition to the ACC-COM-LAN communications module. The HWIM is installed in the controller cabinet, on the ACC Master Module (see ACC-HWIM instructions).

Hardwired communications also requires Hunter GCBL cable. This special cable uses 4 color-coded twisted conductors, shielded with foil, and grounded with an additional bare wire, in direct burial jacket. The cable is also ordered separately.

See the ACC-HWIM instructions for wiring connections.

CONTROLLER SETUP TABLE

Controller Name	Address	IP Address Temp/Fixed	Subnet Mask	Gateway	Primary DNS	Secondary DNS

CONTROLLER SETUP TABLE

Controller Name	Address	IP Address Temp/Fixed	Subnet Mask	Gateway	Primary DNS	Secondary DNS

Hunter®

Hunter Industries Incorporated • The Irrigation Innovators
1940 Diamond Street • San Marcos, California 92078 USA
www.hunterindustries.com

© 2011 Hunter Industries Incorporated

LIT-568 12/11